

# Retail Product Catalogue

# 2023



Flowsell™

[flowsell.com.au](http://flowsell.com.au)

All of the following shelves will fit wall units, double sided gondolas and wall stripping.

### Flat Shelf

Width	600
	915
Depth	305
	405
	505

- white powder coated
- low cost
- easy to clean
- improve shelf management with
  - Mounting Strips
  - Mounting Risers
  - Shelf Dividers

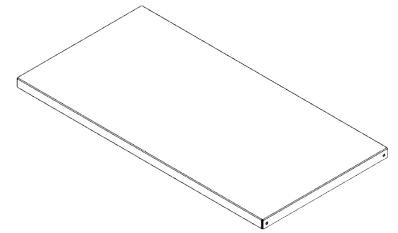

### TrayShelf

Width	600
	915
Depth	305
	405
	505

- slotted for FastFit Dividers
- recess for a clear shelf front
- support pins for cabinets
- superior shelf management
- low cost gravity feed

\* patent & design registration

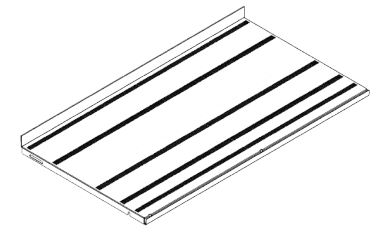

### PullOut TrayShelf

Width	600
	915
Depth	305
	405
	505

- quality drawer runners
- push-pad opening
- self-locking
- superior stock rotation
- improves workflow
- slotted for FastFit Dividers

\* patent & design registration

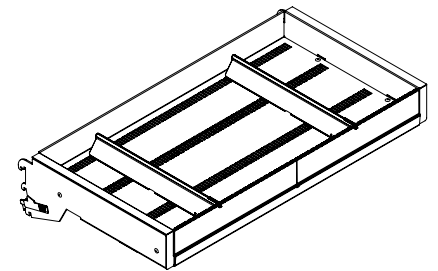

### PullOut Slip Shelf

Width	600
	915
Depth	305
	405
	505

- open base design
- infection & hygiene control
- easy to clean
- quality drawer runners
- push-pad opening
- self-locking
- superior stock rotation
- slotted for FastFit Dividers

\* patent & design registration

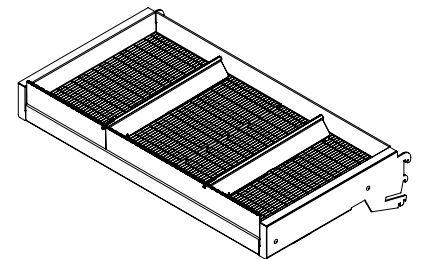

### Wire Shelf

Width	600
	915
Depth	305
	405
	455
	505

- stores bulk & heavy stock
- easy to clean
- chrome finish
- 80kg load rating
- heavy duty brackets

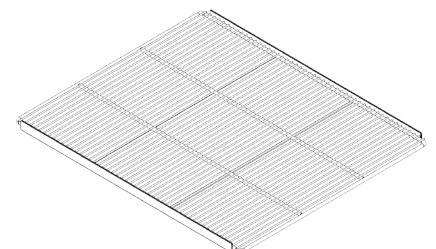

### Smart Shelf

Width	598
Depth	305

- low cost gravity feed
- clear polycarbonate shelf
- permanent clear shelf front
- slotted for FastFit Dividers
- fits brackets or support pins

\* design registration

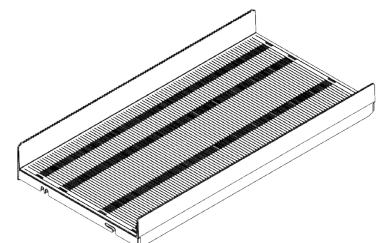

# Gondolas

## Wall Unit

Highly functional wall units and double gondolas that can be easily modified to suit your workspace.

Choose from the different shelf options that suit your shelving needs.

- heavy duty gondola
- white powder coated
- double slotted posts
- adjustable feet
- easy to assemble

Height	1350		
	1550		
	2260		
Depth	Gondola	Shelf	
	407	305	
	507	405	
Width	No. of Bays	600	915
	1	645	960
	2	1246	1876
	3	1850	2794
	4	2450	3710

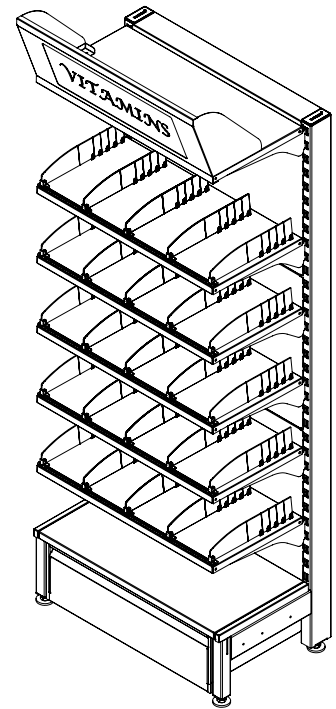

## Gondola Drawer

Width	590
	905
Depth	305
	405

Used to store excess stock at the base of the gondola. Fits wall units and double sided gondolas.

- quality drawer runners
- can be partitioned with FastFit Dividers

505 Gondola uses the 405 gondola drawer

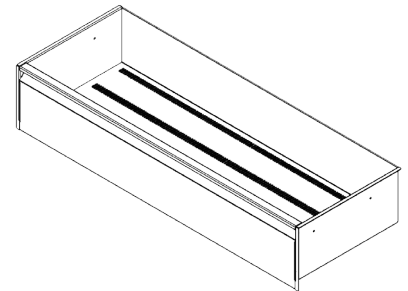

## Double Sided Gondola

Height	1350		
	1550		
	2260		
Depth	Gondola	Shelf	
	740	305	
	940	405	
Width	No. of Bays	600	915
	1	645	960
	2	1246	1876
	3	1850	2794
	4	2450	3710

Ideal for island gondolas for the front of shop.

Choose from the different shelf options that suit your shelving needs.

- heavy duty gondola
- white powder coated
- double slotted posts
- adjustable feet
- easy to assemble

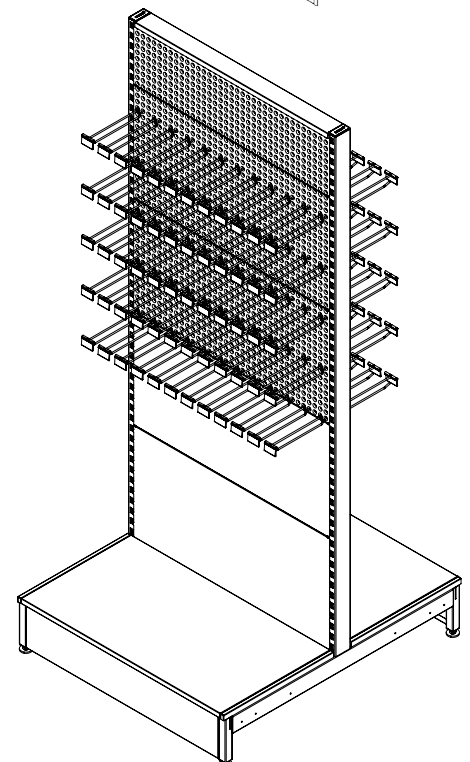

Flowsell® supply heavy duty, zinc plated and black powder coated cool room racking, with wire shelves for freezers or with gravity slides for beverages. They are free standing and easy to install.

### Cool Room Racking

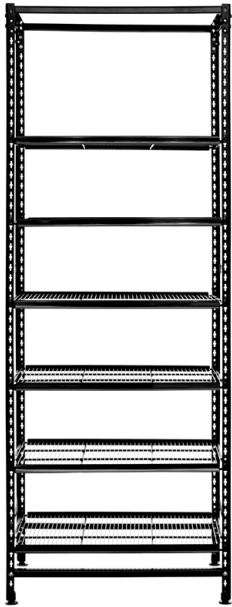

- heavy duty wire shelves
- fit on shelf clips
- security tops & sides for liquor

### Bottle Slide Drink Rack



- high slip polyethylene mat
- tough polycarbonate dividers
- excellent gravity feed
- quick and easy to change dividers
- no destocking for new relays

### Roller Slide Drink Rack

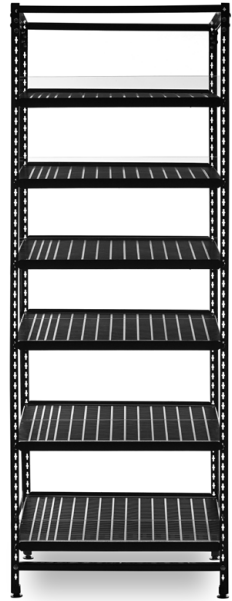

- superior gravity feed mat
- 4mm stainless steel dividers
- unique shelf front with top slots
- dividers lock to slots in the shelf front
- no destocking for new relays

### Drink Rack

Height	2100	
Depth	640	
Width	No. of Bays	
	1	765
	2	1530
	3	2295
	4	3060
	5	3825

### Standard Shelf

Depth	585
Width	740

Two innovative gravity slides that fit existing wire shelves in either your fridge or cool room.

## Bottle Slides

### Shelf Front & FastFit Dividers

Height	50	90	130
--------	----	----	-----

- high slip polyethylene mat
- Polycarbonate Shelf Front
- Dividers lock at rear and onto the top of the Shelf Front
- Excellent gravity feed
- Relay without destocking

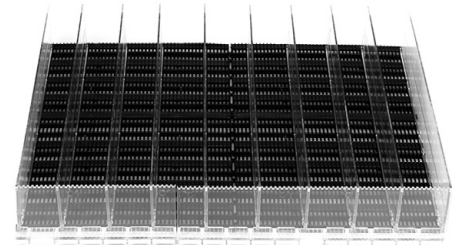

\* Bottle slides can be custom made to fit any wire shelf size

## Roller Slides

### Shelf Front & Wire Dividers

Height	60	90	120
--------	----	----	-----

- Proven platform of rollers
- Polycarbonate slotted Shelf Front
- Non-flexing Wire Dividers with hook
- Prevents stock falling over
- Superior gravity feed
- Reduced gravity angle
- Labor saving

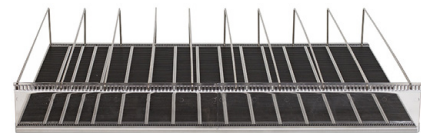

\* Roller Slides require special manufacture for non-standard shelves

A sturdy zinc plated trolley with fixed front and rear brake/swivel heavy duty castors, with a galvanised drip tray in the base. The cost effective trolleys maintain stock rotation and reduce labour costs in cool rooms.

### Flow Trolley

Height	1985
Depth	1045
Width	760

Gravity feed milk trolley on low-friction engineered plastic dividers

- excellent gravity feed
- no trapped milk spills
- easy to clean
- rotates short-dated milk



### Roller Trolley

Height	1985
Depth	1045
Width	760

Gravity feed milk trolley on high slip roller dividers

- aluminium dividers with plastic rollers
- superior gravity feed
- feeds all dairy packs
- lower shelf angle
- easy to clean



Flowsell® have chrome wire racks for back of house storage and with zinc and black epoxy coating for cool rooms.

## Chrome Wire Rack

Height	
1800	2185
Depth	Width
355mm	603mm
355mm	1213mm
457mm	603mm
457mm	908mm
457mm	1213mm
457mm	1518mm
457mm	1822mm
610mm	908mm
610mm	1213mm
610mm	1518mm
610mm	1822mm

## Epoxy Wire Rack

Height	
1800	
Depth	Width
355mm	603mm
355mm	1213mm
457mm	603mm
457mm	908mm
457mm	1213mm
457mm	1518mm
457mm	1822mm
610mm	908mm
610mm	1213mm
610mm	1518mm
610mm	1822mm

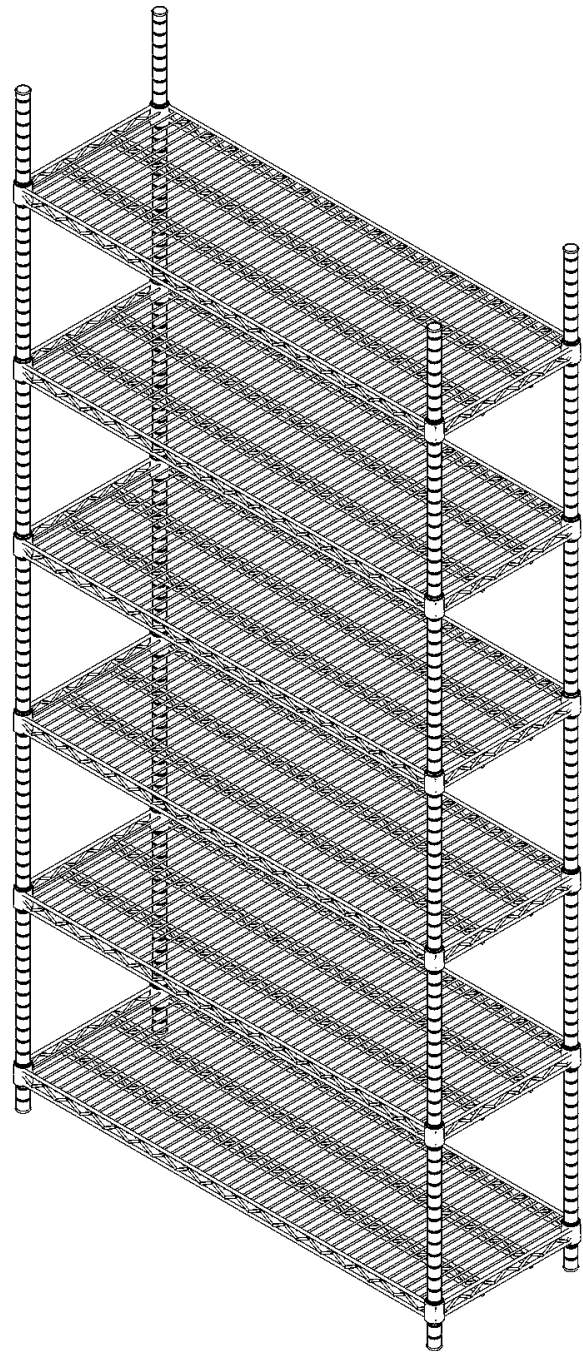

All wire racks are manufactured to the highest quality and come with a five-year guarantee. They are ideal for storing product in bulk stores. Racks have NSF and salt test certification.

- easy to assemble
- 250kgs load per shelf (spread evenly)
- quality chrome or epoxy finish
- corrosion resistant

Flowsell® roll cages have a high quality silver galvanised finish, with an optional full or part powder coating, and two swivel and two fixed castors. The roll cages are rust resistant and come with a five-year guarantee.

RC201

RC202

RC301

RC401-SR

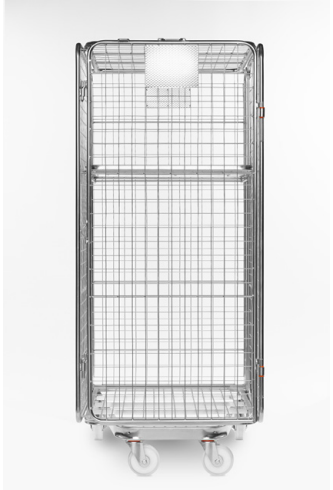

- two sided
- foldable & nestable
- load rating 450kgs
- optional detachable shelf
- custom sizes available

- two sided
- nestable
- load rating 450kgs
- two stage stacking
- custom sizes available

- three sided
- foldable & nestable
- load rating 300 - 400kgs
- two stage stacking
- custom sizes available

- four sided
- security door
- foldable & nestable
- heavy duty
- load rating 600kgs
- castor type optional
- custom sizes available

	RC201	RC202	RC301	RC401-SR
Height	1700	1790	1690	1680
Depth	800	800	850	850
Width	715	760	735	735